

Puppi Móbile
Rua Ema Tanner de Andrade, 965
Vila Ferrari - Campo Largo - Paraná
e-mail: puppimobile@puppimobile.com.br
fone: (41) 3392-1626

MANUAL DE INSTRUÇÕES

COMODA CAPRI C/ PORTA REF: 20656 C/ PUXADOR E PÉS MEL

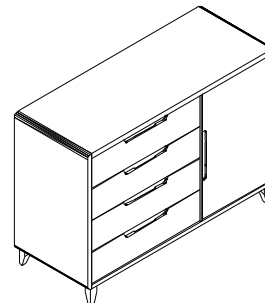









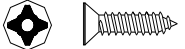
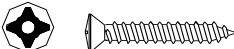

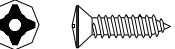

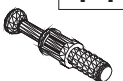

Linha Color
/07 - Navy
/09 - Cinza Gianduia
/11 - Rose
/13 - Jade
/14 - Nude

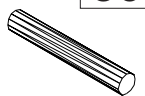
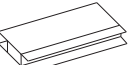
 **PUPPI**
MOBILE

Medida C: 1315 L/C 920 P 515
Peso Suportado: 3Kg por gaveta

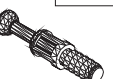
1. Leia atentamente todo o manual de instruções antes de iniciar a montagem.
2. A montagem do produto deverá ser feita em superfície limpa e plana.
Aconselhamos utilizar a própria embalagem para forrar o chão a fim de não danificar o produto.
3. Reservar área livre p/ montagem do produto.
4. Evitar batidas e contato com objetos cortantes.
5. A abertura das gavetas devem ser feitas uma de cada vez para evitar tombamento.
Nunca deixar mais de uma gaveta aberta ao mesmo tempo. Não fazer escalada nas gavetas.
6. Quando a gaveta estiver aberta, não se apoiar sobre a mesma.
7. Fixar o kit anti-tombamento de segurança para evitar acidente.

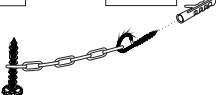
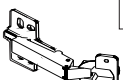
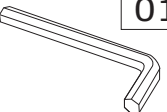
A 05  Paraf. soberbão 7x70 cab chata	B 52  Paraf. 4x14 cab chata	C 08  Paraf. 3,5x35 cab flange	D 08  Paraf. 3,5x20 cab chata
E 15  Paraf. 3,5x12 cab chata	F 02  Suporte cabideiro	G 26  Tampa minifix	H 14  Paraf. minifix M6x7,5
I 26  Tambor minifix	J 14  Buchas minifix	K 08  Fixador fundo de gaveta	L 50  Cavilha 8x40
M 1  Perfil "H" 1265mm	N 36  Pregos	O 02  Sachê de cola	P 04  Corrediça telescópica (PAR)
Q 12  Paraf. minifix M4	R 06  Suporte prateleira	S 01  Kit anti-tombamento	T 02  Dobradiça caneco 35mm
U 01  Chave allen 4mm			

Porta (03)

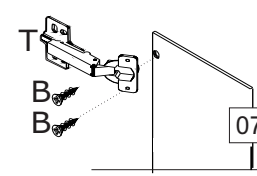

1º PASSO - Ao fixar o calço da dobradiça, use o furo oblongo (os da ponta).

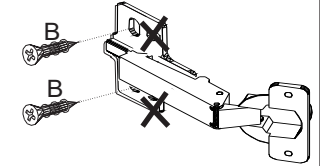

2º PASSO - Somente após regular a porta prenda com os demais furos

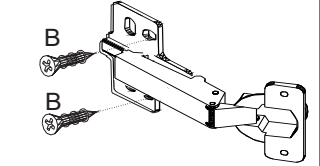

Kit anti-tombamento

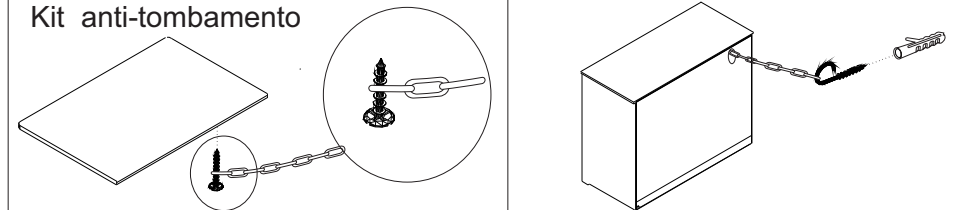

1º passo- antes de prender o encosto fixar a corrente com parafuso no lado de baixo do tambo

2º passo - fazer um furo no encosto e passar a corrente

3º passo - fixar a outra extremidade do kit: fazer furação na parede com broca 6mm e colocar o gancho na bucha e engatar a corrente.

Encosto (14 e 15)

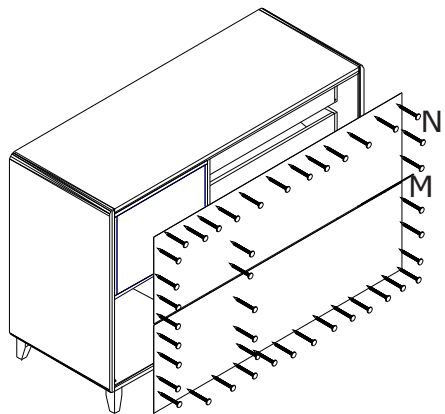

Montar gavetas

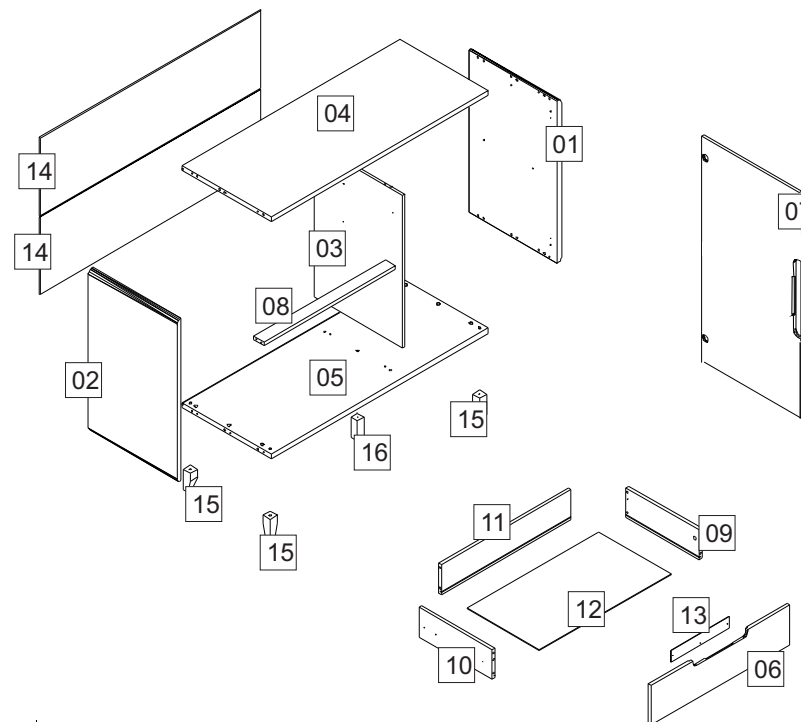
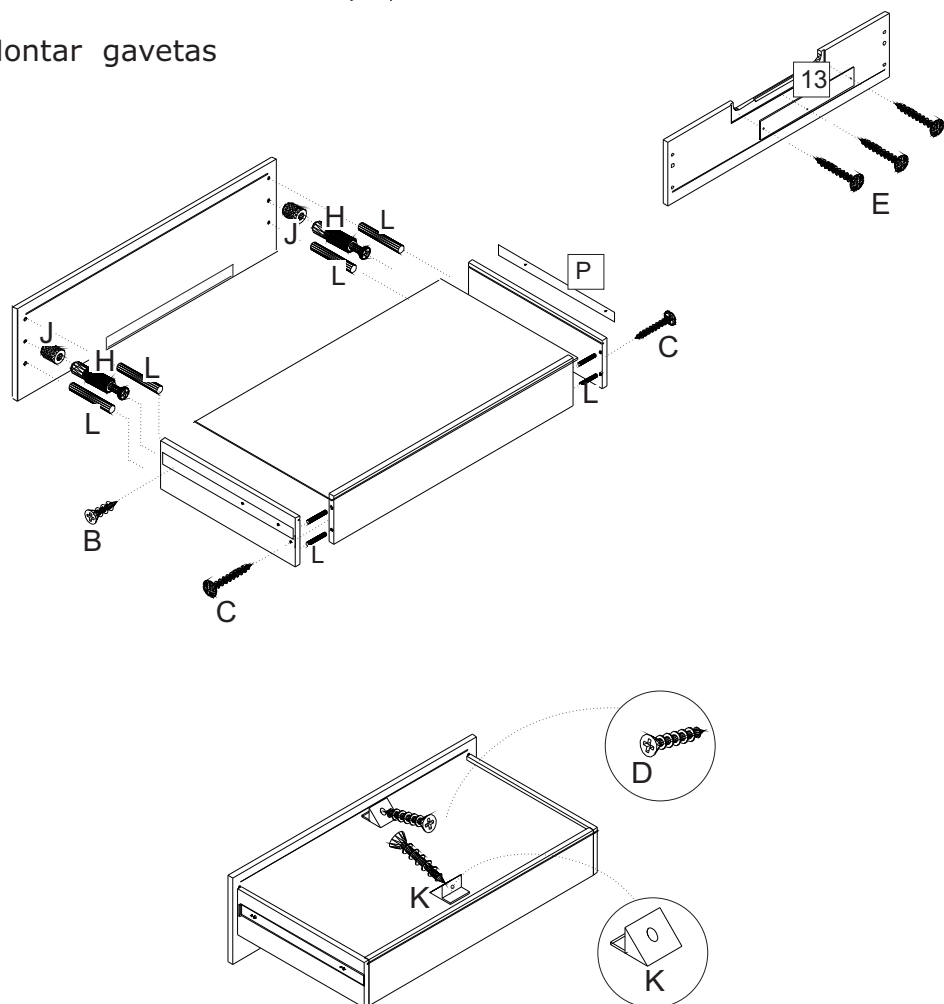

Item	COMPONENTES	Quant.
1	LATERAL DIREITA	1
2	LATERAL ESQUERDA	1
3	DIVISÓRIA	1
4	TAMPO	1
5	BASE	1
6	FRENTE GAVETA	4
7	PORTA	1
8	TRAVESSA	1
9	LATERAL DIR GAVETA	4
10	LATERAL ESQ GAVETA	4
11	TRASEIRA GAVETA	4
12	FUNDO GAVETÃO	4
13	ESPELHO PUXADOR	5
14	ENCOSTO	2
15	PÉ	4
16	PE CENTRAL	1

Montar Lateral direita (01)

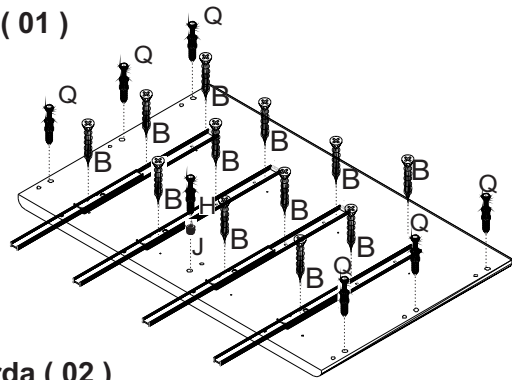

Montar Lateral esquerda (02)

- Item (T) serve de suporte para o nicho

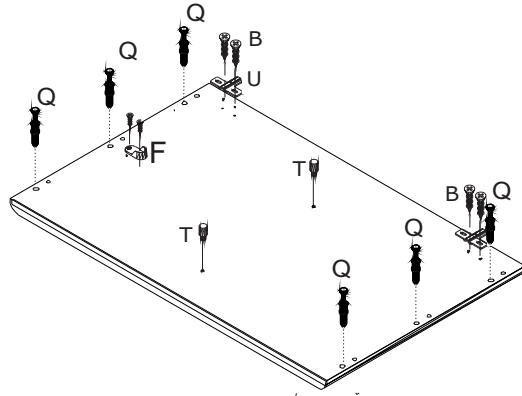

Divisória (03)

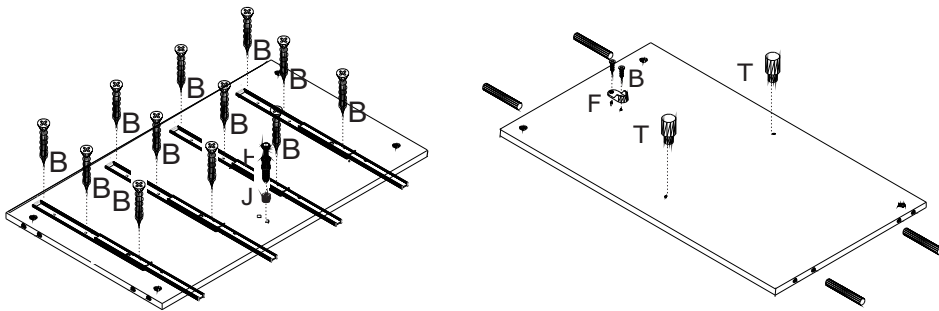

Tampo (04)

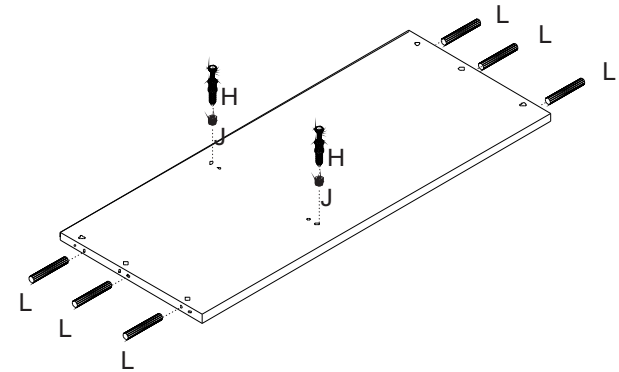

Base (05)

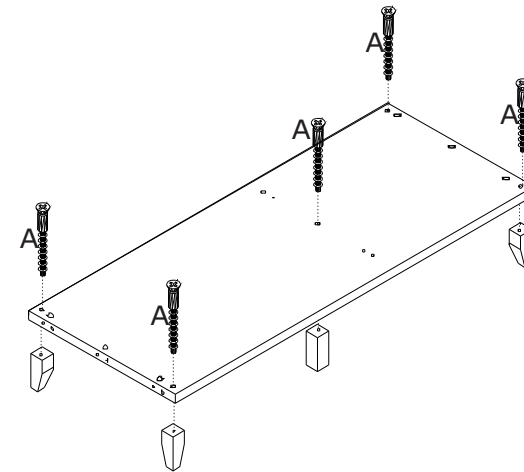

Fixar travessa (08)

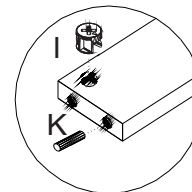

Para travessa usar tambor mini fixi (F) , e cavilha (K)